

1108

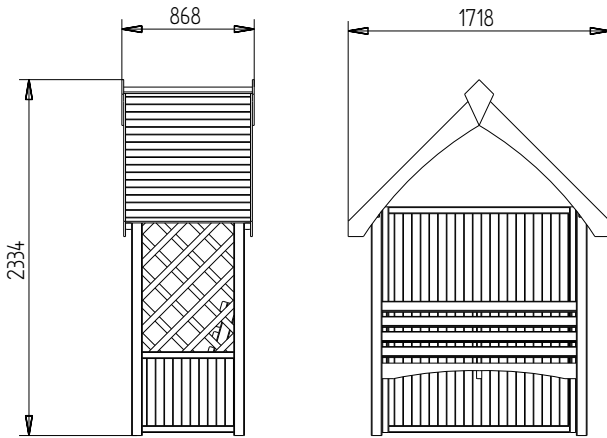

**Important : Assembly of this Pergola requires two people.**

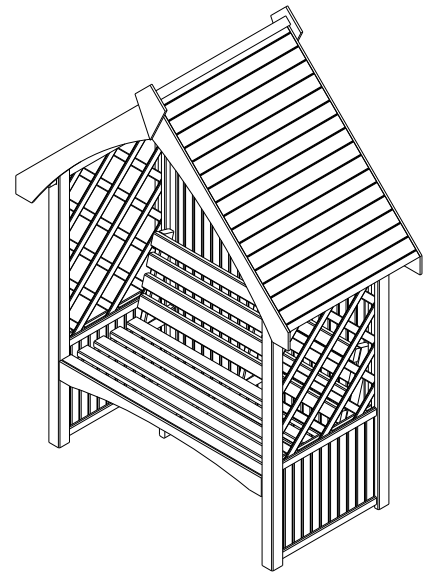

JE

Thank you for choosing this Arbour manufactured by the UK's largest manufacturer of timber garden products. In order to gain the most benefit from it, please note the following:

- Exercise particular care and follow instructions.
- This Arbour is pressure treated. For extra protection from the elements we recommend that you treat your structure using a wood preservative treatment. Apply in accordance with the manufacturers instructions.
- Please ensure that you thoroughly check all component parts for quantity and quality before you commence building the product. If there are any missing parts, please contact the help line as shown immediately. The manufacturer cannot be held liable for damaged items once any part of the product has been fitted or altered in any way (e.g. Painted)
- Timber is a natural material. It will shrink and swell as a result of varying moisture content.
- Please keep all plastic bags and small parts away from children in order to reduce the risk of suffocation.
- Important Note : Do not lean or stand on rafters during assembly they are not load bearing.
- If there are any technical queries with the product, please contact our customer help line on 0844 248 9853 between the hours of 8.30 am and 5.00 pm Monday to Friday.

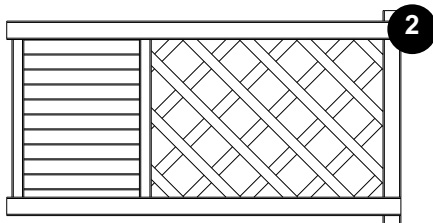

SASA

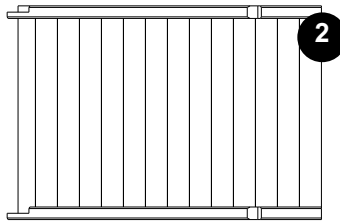

SARFS

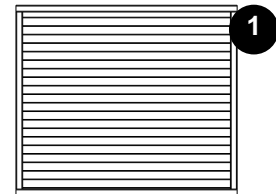

SABP

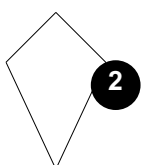

SAFIN

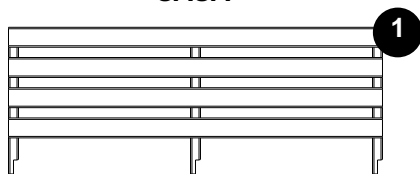

SABBACK

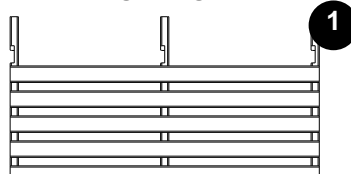

SABBOT

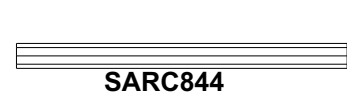

SARC844



SAINS163

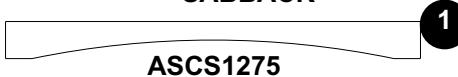

ASCS1275

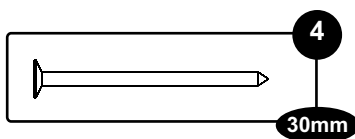

30mm

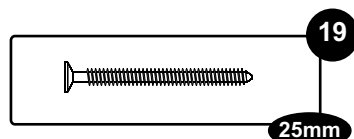

25mm

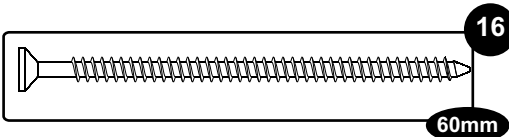

60mm

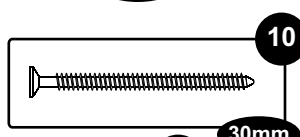

30mm

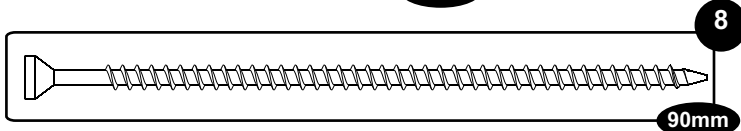

90mm

**REQUIRED TOOLS : (NOT SUPPLIED)**



DRILL



POZI DRIVE SCREWDRIVER



SPIRIT LEVEL



TAPE MEASURE



HAMMER

1

Place the **SABBOT** and the **SABBACK** together so that the notches slot inside one another.

Secure them together by using 2x30mm screws where the assemblies join.

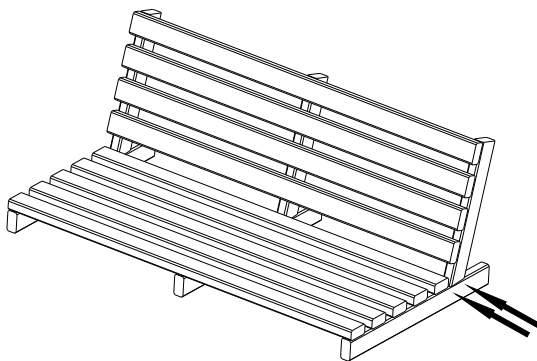

2

Lie the **SASA** down and position the completed seat assembly, that you have previously constructed, 373mm from the base of the **SASA**.

Again, making sure that all sides are flush fix in place by screwing through the **SABBOT** and the **SABBACK** into the **SASA** using 60mm screws as shown.

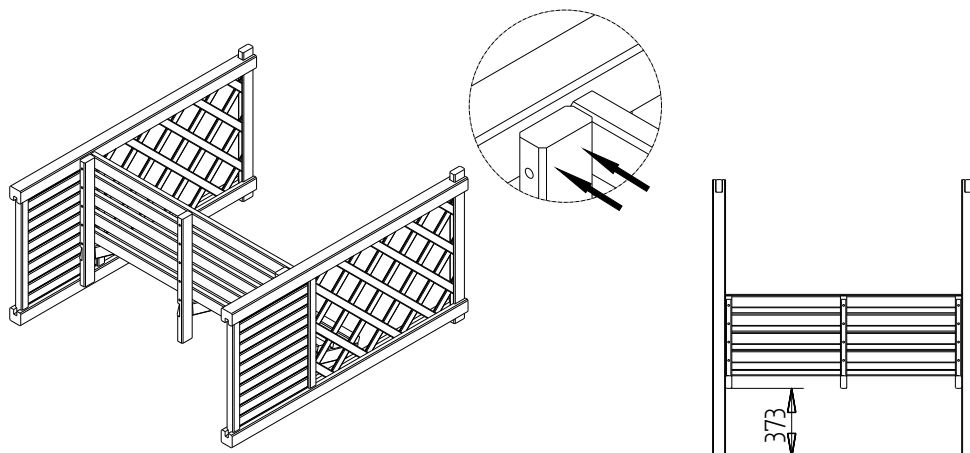

3

Stand the product up and place the **SABP** so that it fits squarely between the two **SASA** sections and is in line with the top.

Secure into position by screwing through the two back posts of the **SASA**'s, into the **SABP** using 4x90mm screws per post.

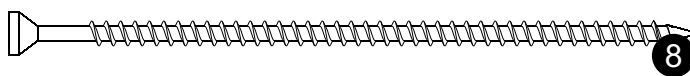
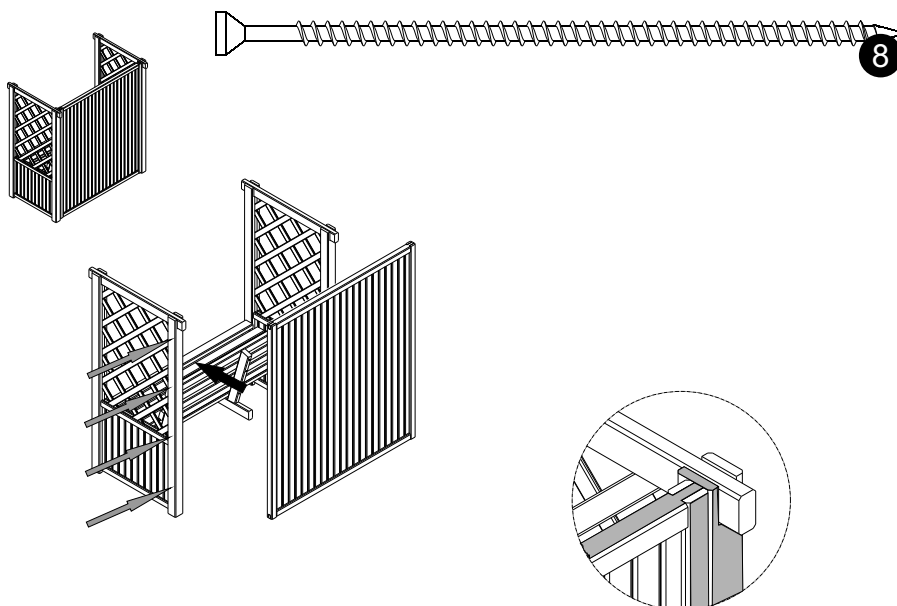

4

Place the two **SARFS** together so that they slot together at the apex as shown.

Making sure that they are tight and flush, fix them together by screwing, from the outside inwards, using 2x30mm screws on each join.

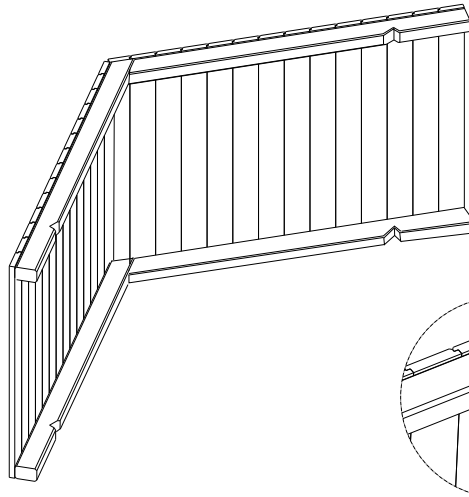

5

Place the completed roof onto the Arbour so that the notches of the **SARFS** sections sit on the **SASA** as shown.

Secure in place by screwing through the top batten of the **SASA** into the **SARFS** using 60mm screws.

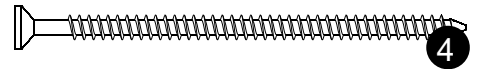
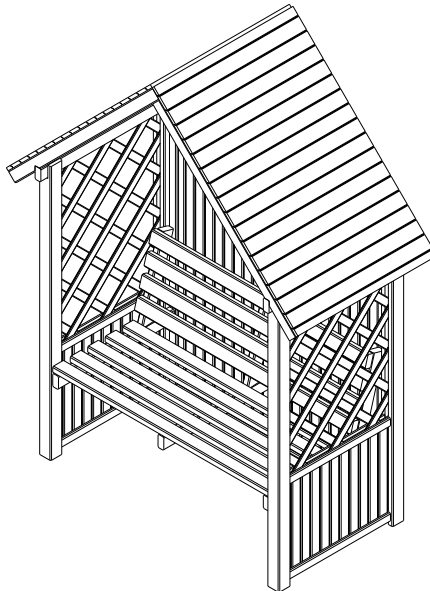

6

Place the **SARC844** onto the top of the roof and position so that it covers up the join at the apex. Secure in place using 3x25mm screws

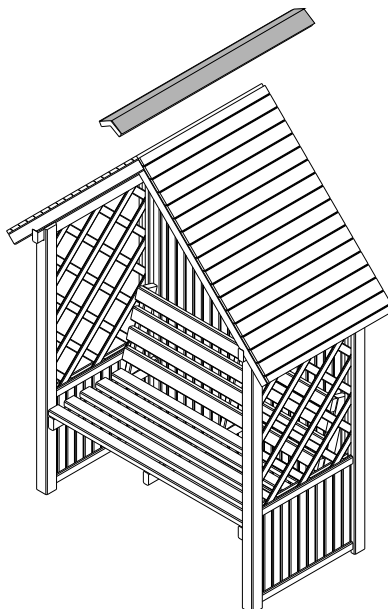

7

Place the **SAINS163** so that they are in line with the apex and flush with the outside of the roof.

Secure each in place using 3x25mm screws

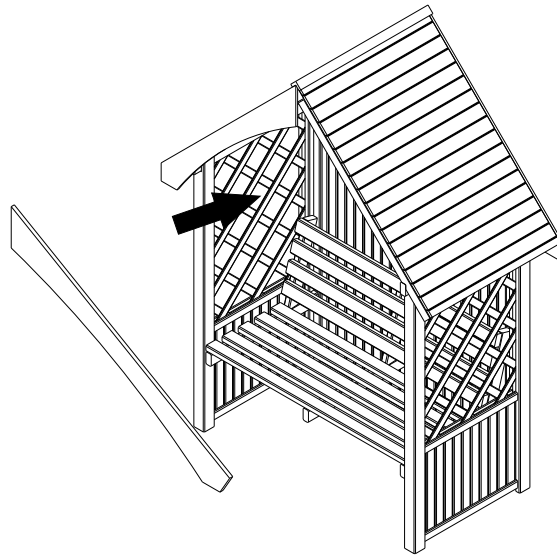

8

Place the **SAFIN** over the join of the two **SAINS163** as shown.

Secure each in place using 2x30mm nails.

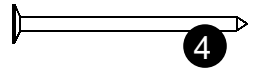
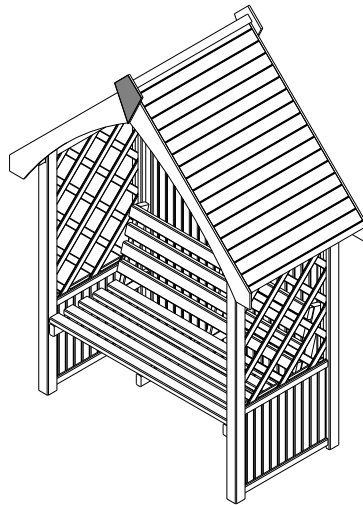

9

Place the **ASCS1275** against the seat so that it is tight on all sides and in line with the seat

Secure in place using 4x25mm screws.

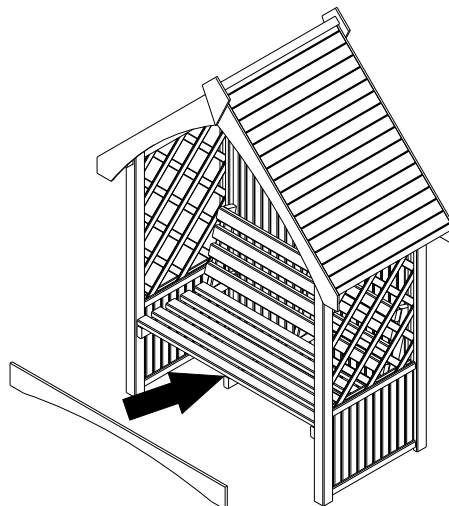

Forest Garden plc.  
Units 291 & 296 Hartlebury Trading Estate  
Hartlebury  
Worcestershire  
Dy10 4JB

Customer Services: 0844 248 9853  
E-mail: [info@forestgarden.co.uk](mailto:info@forestgarden.co.uk)

[www.forestgarden.co.uk](http://www.forestgarden.co.uk)