

# PARSLEY PLAYHOUSE

0209

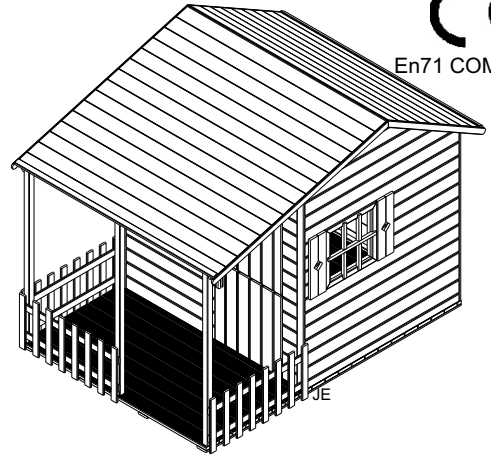
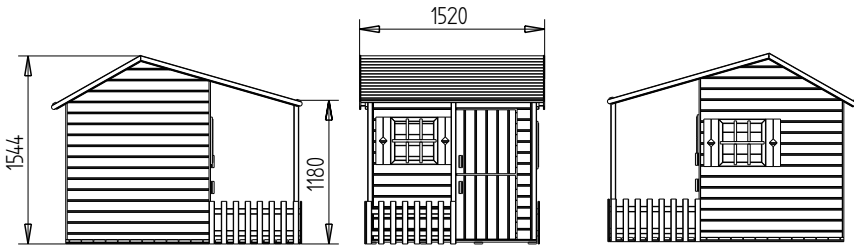

**Important : Assembly of this product requires two people.**

**“IMPORTANT, RETAIN FOR FUTURE REFERENCE: READ CAREFULLY”**

Thank you for choosing this garden building manufactured by the UK's largest manufacturer of timber garden products. In order to gain the most benefit from it, please note the following:

- Exercise particular care and follow instructions whilst cutting the roofing felt. If it is cut incorrectly, additional roofing felt can be inexpensively purchased from most good DIY retailers or garden centres.
- This building is pressure treated to ensure longevity of all timber components and protect against rot. This may leave a colour difference on some parts that will even out as the moisture content stabilises.
- If there are any technical queries with the product, please contact our customer help line on 0844 248 9853 between the hours of 8.30 am and 5.00 pm Monday to Friday.
- Timber is a natural material. It will shrink and swell as a result of varying moisture content.
- Please ensure that you thoroughly check all component parts for quantity and quality before you commence building the product. If there are any missing parts, please contact the help line as shown immediately. The manufacturer cannot be held liable for damaged items once any part of the product has been fitted or altered in any way (e.g. Painted)
- Please keep all plastic bags and small parts away from children in order to reduce the risk of suffocation.
- Make sure that you are building this product on a firm level base.
- This product is for DOMESTIC USE ONLY.

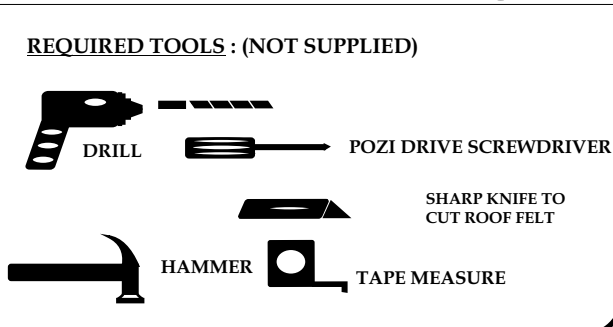
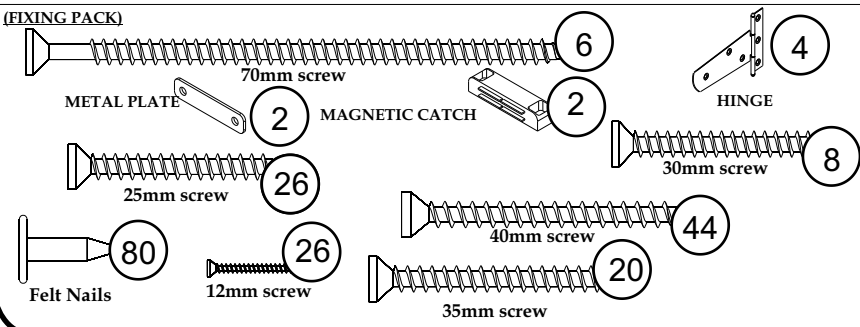
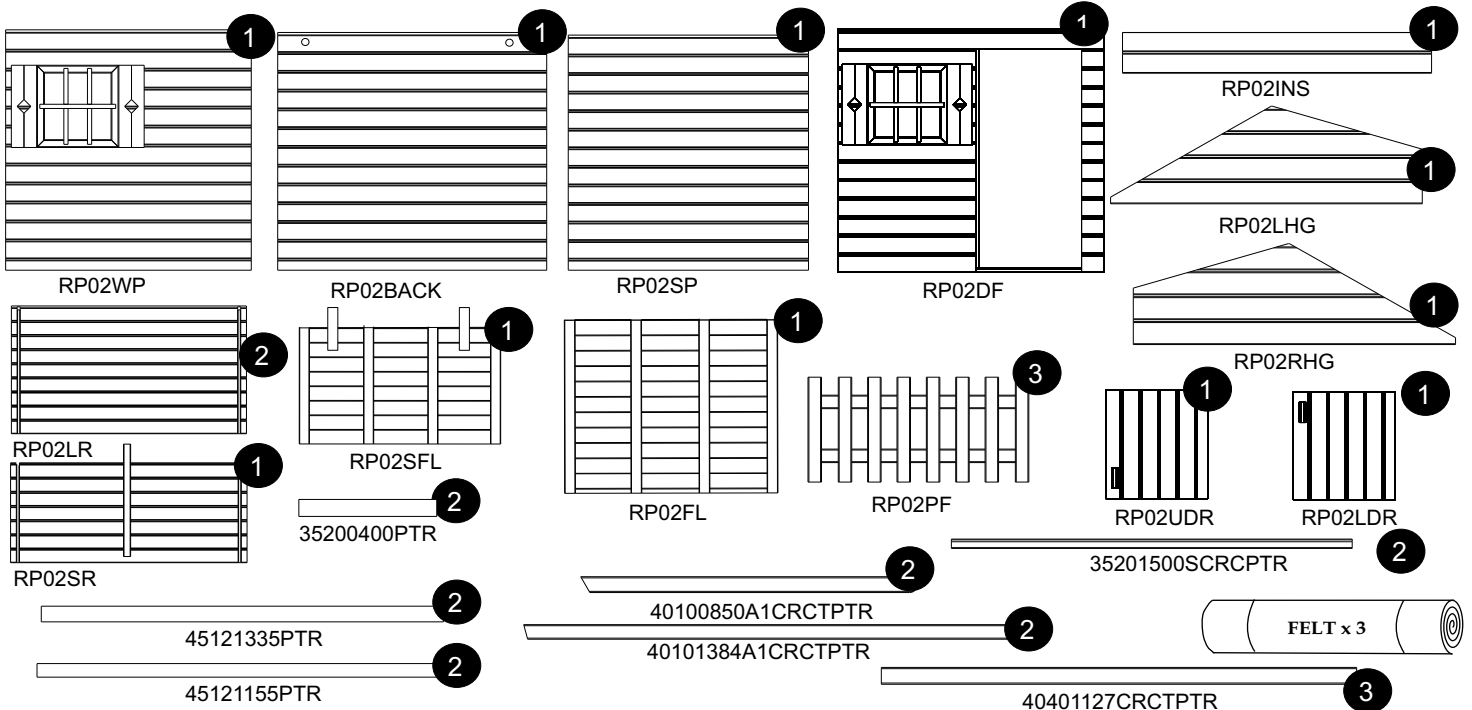

1

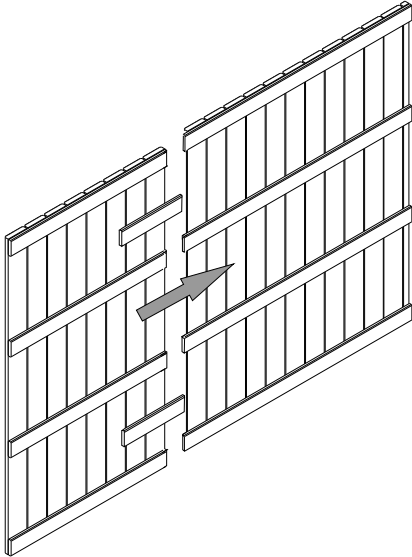

Slot the two floor section (**RP02FL** and **RP02SFL**) together on the floor. Make sure that the smaller section is towards the back of the building. Do not fix together.

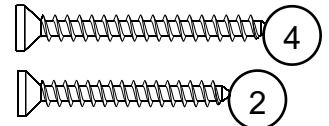

2

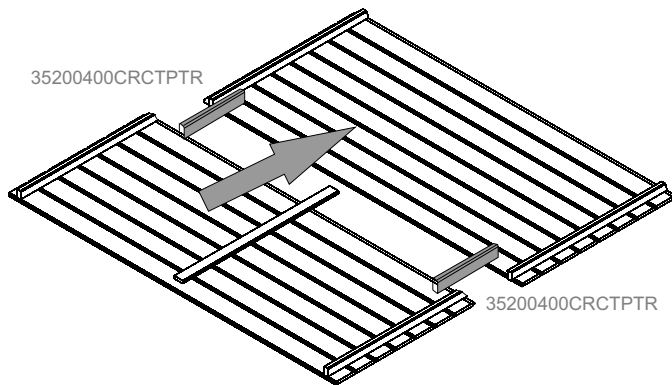

Fit the **RP02SR** to one of the **RP02LR** sections as shown. Using the 2x **35200400CRCTPTR**, bridge the gap between the roof sections as shown and secure each using 2x35mm screws.

Using the 2x 25mm screws screw through the middle batten into the **RP02L**.

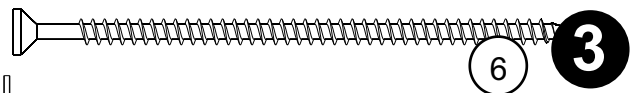

3

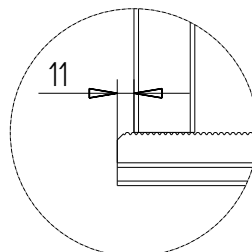
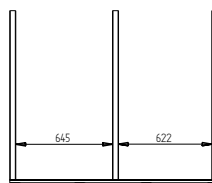
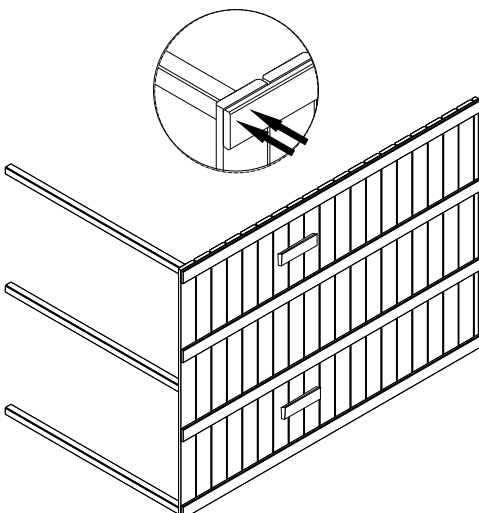

Place the three **40401127CRCTPTR** against the **RP02FL**, positioned as shown.

Secure each in place, screwing through the **RP02FL** into the **40401127CRCTPTR** using 2x70mm screws for each.

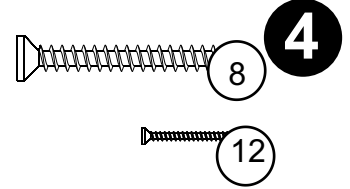
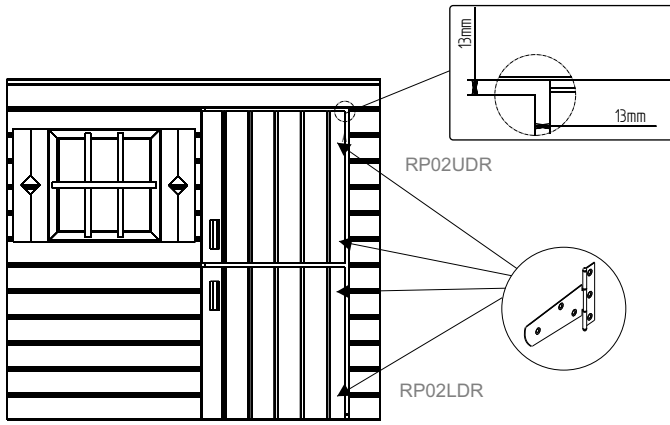

4

Place the hinges on each of the doors, **RP02UDR** and **RP02LDR**, so that they are 95mm from the top and bottom. Secure the hinge to the door using 3x12mm screws. Whilst the **RP02DF** door front is lay flat position the doors so that there is an equal gap of 13mm as shown. Secure the doors in place by securing the other half of the hinge to the door front using 2x30mm screws.

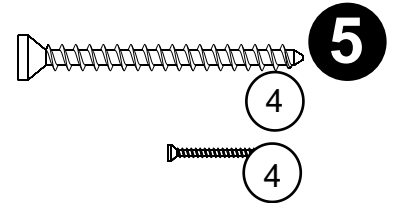
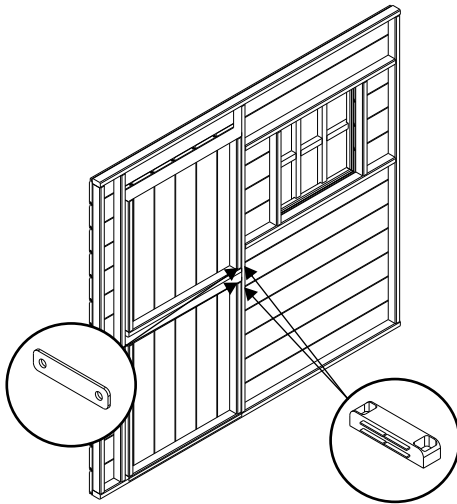

5

Place the magnetic plates on the inside of each door against the boards. Secure in place using 2x12mm screws. Line up the magnetic catches and secure against the batten of the **RP02FR** door frame, using 2x35mm screws for each.

MAGNETIC PLATE

MAGNETIC CATCH

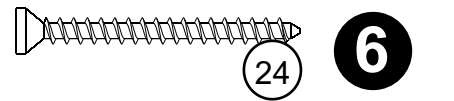
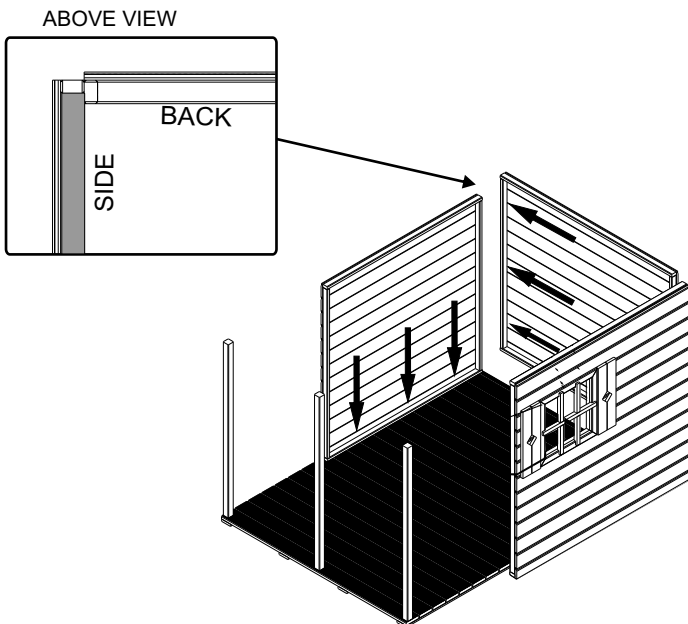

6

Place the **RP02SP** onto the **RP02FL** as shown so that it is flush with the outside and the back. Place the **RP02BACK** in the same manner and attach to the **RP02SP** using 3x40mm screws, screwing through the **RP02BACK** into the **RP02SP**.

Repeat this step for the remaining **RP02WP** and **RP02CF**.

Secure all four panels to the **RP02FL** using a further 3x40mm screws per panel.

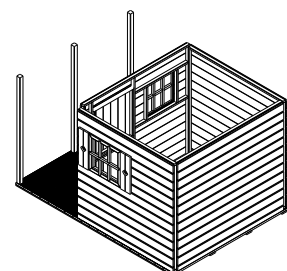

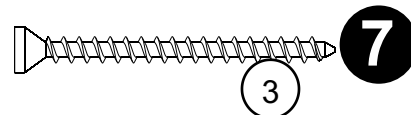
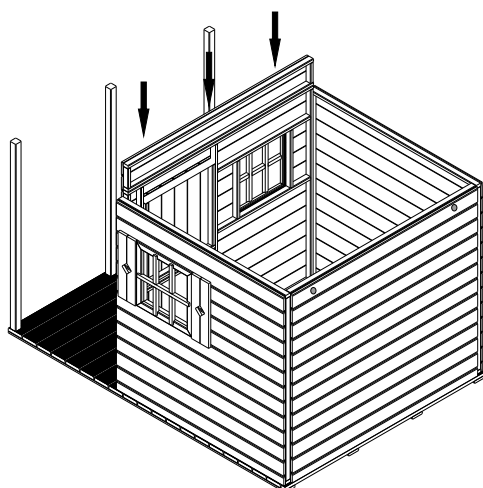

Place the **RP02INS** onto the **RP02CF** making sure it slots neatly into the place and is flush on all sides.

Secure in place using 3x40mm screws, screwing down into the **RP02CF**

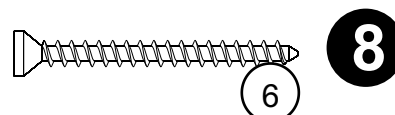
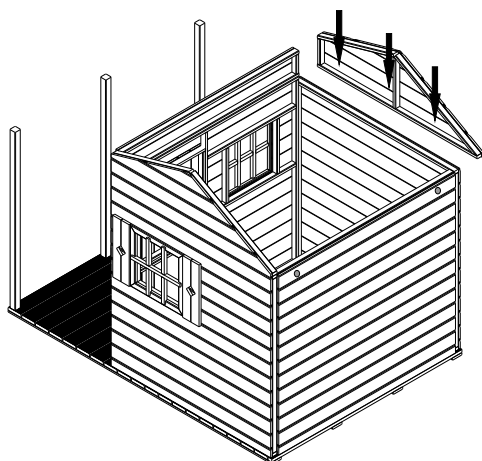

Place the **RP02LHG** and the **RP02RHG** onto the building as shown, making sure that they line up neatly on all sides and are flush.

Secure each in place using 3x40mm screws, screwing into the Panel underneath.

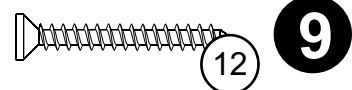
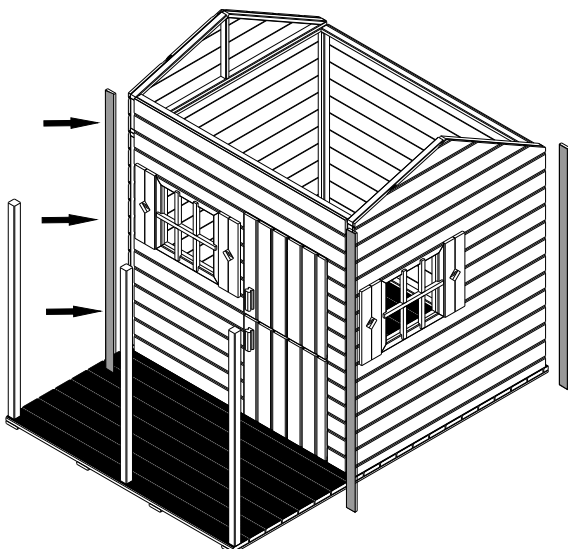

Fix the two **45121335PTR** (corner strips) to both sides of the **RP02CF** so that they cover the join where the two panels meet.

Secure each in place using 3x25mm screws.

Repeat this procedure with the two **45121155PTR** for the **RP02BACK**.

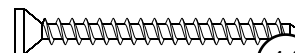

11

10

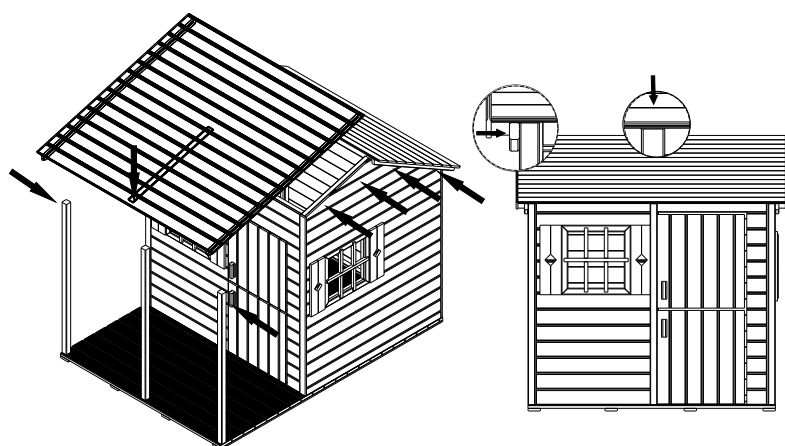

Place the **RP02SR** and **RP02LR** on to the building as shown. Make sure the batten in the centre of the **RP02LR** is towards the front of the building.

Secure both roof sections in place screwing through the battens from the outside into the building using 2x40mm screws per batten.

The **RP02LR** also needs securing to the three **40401127CRCTPTR** (posts).

For the two outer **40401127CRCTPTR**'s, fix the **RP02LR** to these by screwing through the batten into the post using 1x40mm screw per post.

For the central **40401127CRCTPTR** screw down through the **RP02LR** into the post

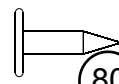
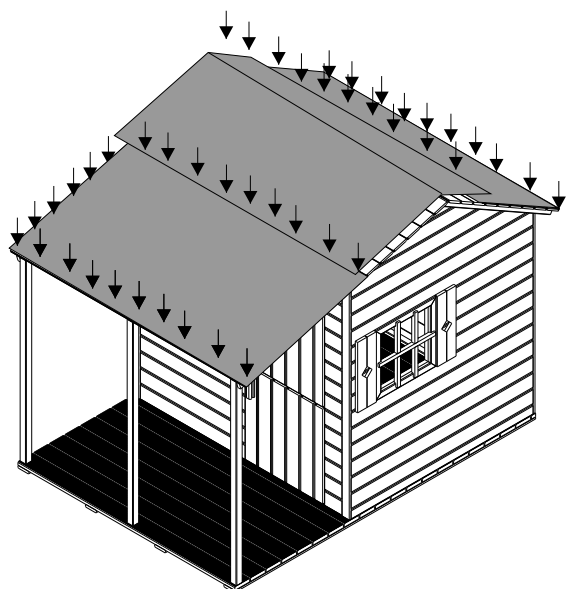

80

11

Place the felt onto the building as shown making sure that each piece is flush with the sides and does not overhang. Place the middle strip so that it overlaps the others.

Secure the felt in place using felt nails spaced out 150mm apart.

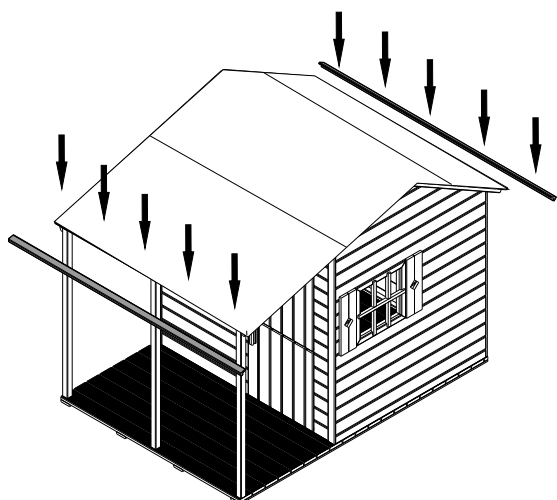

10

12

Fix the two **35201500SCRCTPTR** to the overhang of the **RP02LR** and the **RP02SR** so that it overlaps the felt. Secure each in place using 5x13mm screws.

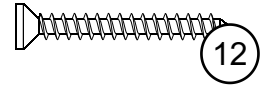

13

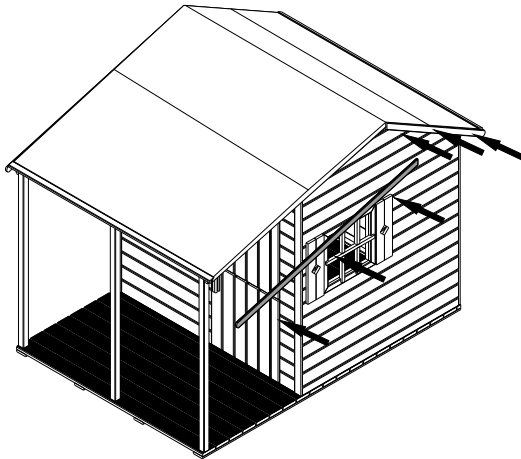

Place the **40100850A1CRCTPTR** and the **40101384ACRCTPTR** against the sides of the building so that each is flush with the top of the roof and they meet up to one another at the apex.

Secure them in place using 3x25mm screws for each.

Trim off any excess felt that may be sticking out

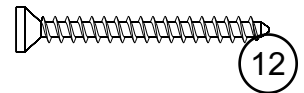

14

12

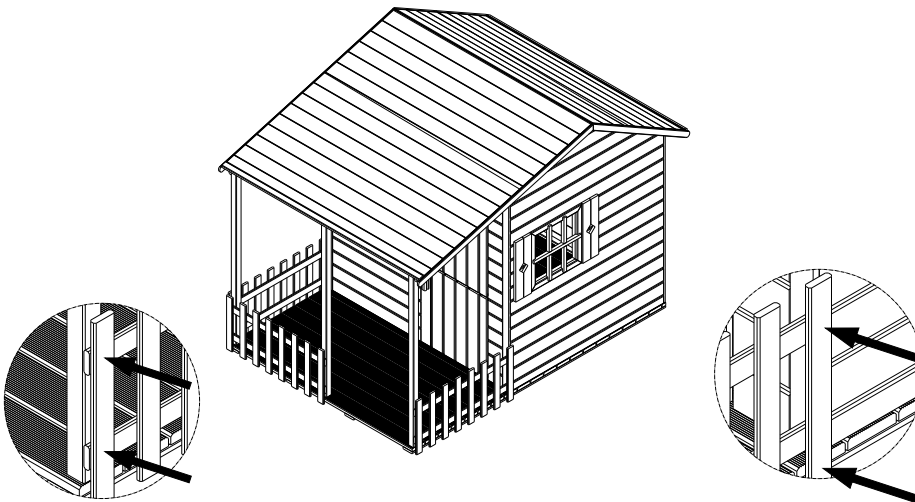

Position the **RP02PF**'s as shown.

Using 35mm screws secure the **RP02PF**'s in position as shown