



IMPORTANT:
ASSEMBLY OF THIS
SHED REQUIRES TWO
PEOPLE

IMPORTANT, RETAIN FOR FUTURE REFERENCE: READ CAREFULLY

ISSUE 0310

Thank you for choosing this garden building manufactured by the UK's largest manufacturer of timber garden products. In order to gain the most benefit from it, please note the following:

- Exercise particular care and follow instructions whilst cutting the roofing felt. If it is cut incorrectly, additional roofing felt can be inexpensively purchased from most good DIY retailers or garden centres.

- Most buildings are pre-treated with a factory base coat for protection during storage and transit. We recommend that you treat your new building as soon as possible after assembly, using a wood preservative treatment. Apply in accordance with the manufacturers instructions.

- Please ensure that you thoroughly check all component parts for quantity and quality before you commence building the product. If there are any missing parts, please contact the help line as shown immediately. The manufacturer cannot be held liable for damaged items once any part of the product has been fitted or altered in any way (e.g. Painted)

- Timber is a natural material. It will shrink and swell as a result of varying moisture content.

- Please keep all plastic bags and small parts away from children in order to reduce the risk of suffocation.

REQUIRED TOOLS : (NOT SUPPLIED)

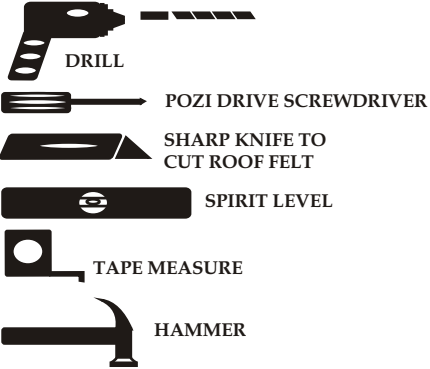

FIXING PACK (GSS10FP) CONTENTS :

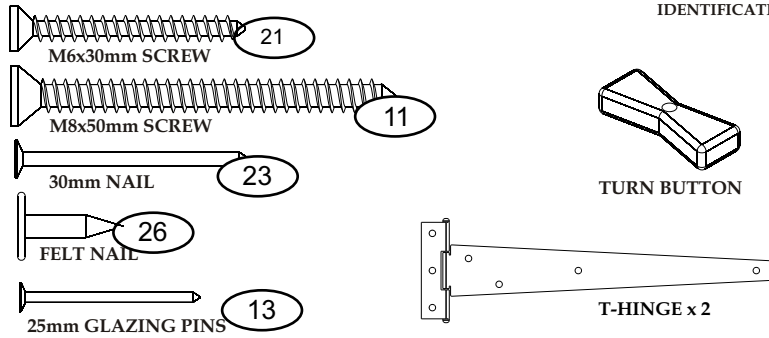

PLEASE NOTE: ALL SCREWS AND NAILS SHOWN BELOW AND IN INSTRUCTIONS ARE TO SCALE TO ASSIST IN IDENTIFICATION OF REQUIRED FIXINGS.

FRONT PANEL x 1 (SGSS10FRONT)

RH SIDE x 1 (SGSS10RHIDE)

OSB FOR THE ROOF 1118x678x8mm QTY 1 (11186788)

OSB FOR BACK: 1456x1015mm QTY 1 (145610158)



FIXING PACK x 1



FELT x 1
85060 GREEN MINERAL FELT

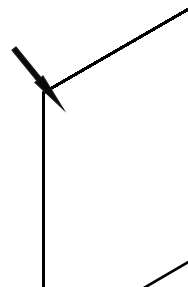
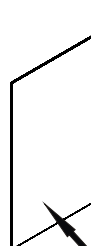
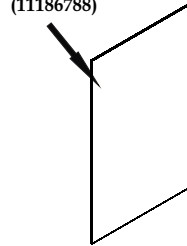
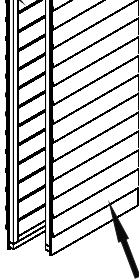
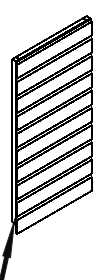
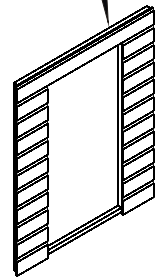

FRONT PANEL x 1 (SGSS10DOOR)

LH SIDE x 1 (SGSS10LHIDE)

OSB FOR THE FLOOR 1015x570x8mm QTY 1 (10155708)

28280570PTR QTY3
BATTEN 28x28x570mm

28280633DTR QTY2
BATTEN 28x28x633mm

282801118DTR QTY 1
BATTEN 28x28x1118mm

1

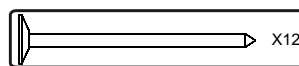

Batten 28280570PTR

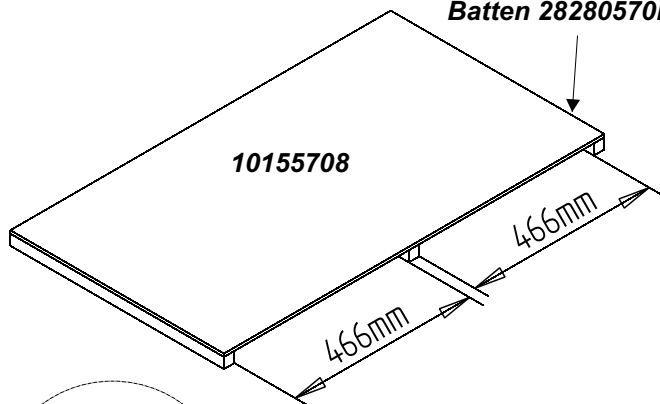

PLACE THE SHEET FOR THE FLOOR OVER THE THREE 570mm BATTENS AS SHOWN. MAKE SURE THAT THE BATTENS ARE POSITIONED TO THE DIMENSIONS SHOWN AND THAT THEY ARE FLUSH.

FIX EACH BATTEN IN PLACE USING 4x30mm NAILS

2

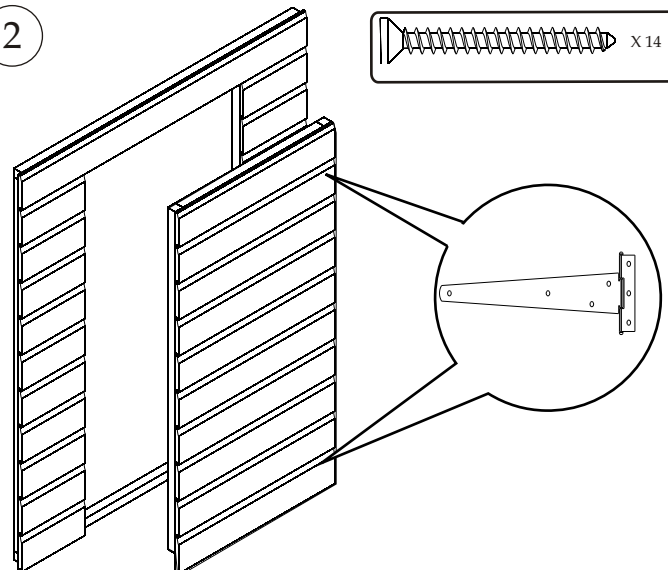
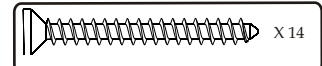

FIX THE TWO HINGES TO THE RIGHT HAND SIDE OF THE DOOR USING 30mm SCREWS. MAKE SURE THAT THE SCREWS LOCATE INTO THE BATTENS BEHIND.

PLACE THE DOOR IN TO THE DOOR PANEL AND SECURE THE OTHER PART OF THE HINGE TO THE PANEL.

3

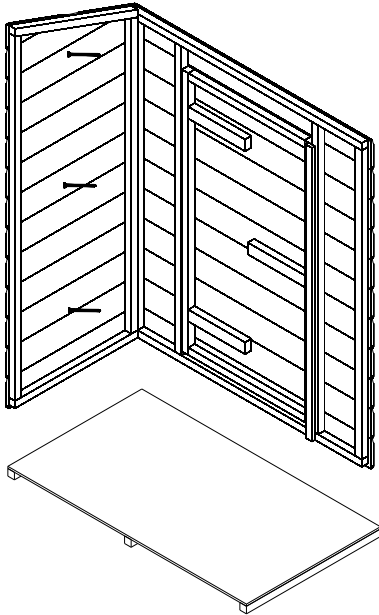
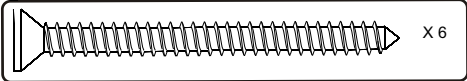

FIX THE **SGSS10RHSIDE** (RIGHT HAND SIDE PANEL) TO THE COMPLETED FRONT PANEL USING 3x50mm SCREWS AS SHOWN.

REPEAT THE STEP WITH THE **SGSS10LHSIDE** (LEFT HAND SIDE)

4

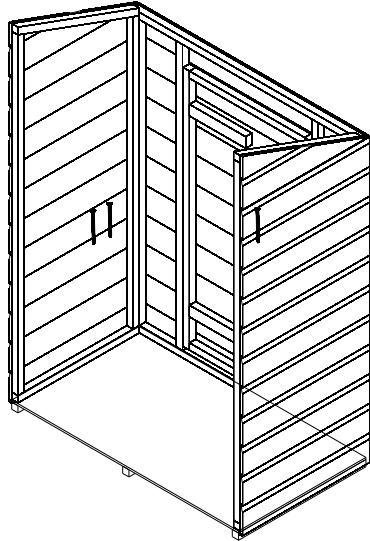
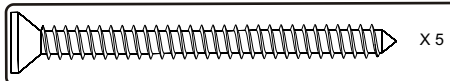

PLACE COMPLETED FRONT AND SIDES ON TO THE FLOOR AND MAKE SURE THAT ALL THE CORNERS ARE SQUARE.

SECURE IN PLACE USING 5x50mm SCREWS, SCREWING INTO THE BATTENS UNDERNEATH.

5

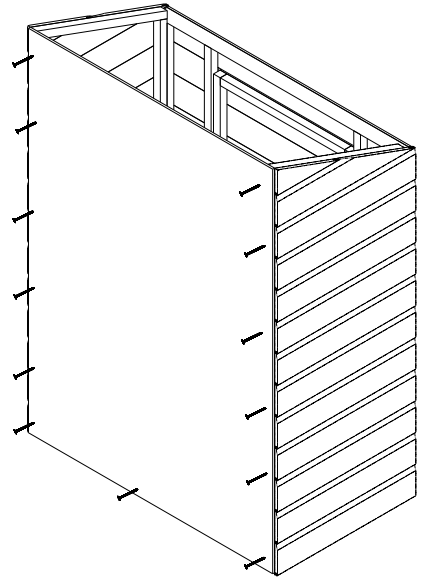
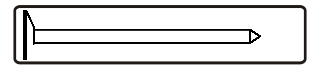

PLACE THE **145610158** (OSB BACK) ON TO THE BACK OF THE STRUCTURE. AGAIN MAKING SURE THAT THIS IS FLUSH ON ALL SIDES, SECURE IN PLACE USING 13x30mm NAILS AS SHOWN.

TAKE CARE THAT THESE ARE LOCATED PROPERLY INTO THE BATTENS BEHIND

6

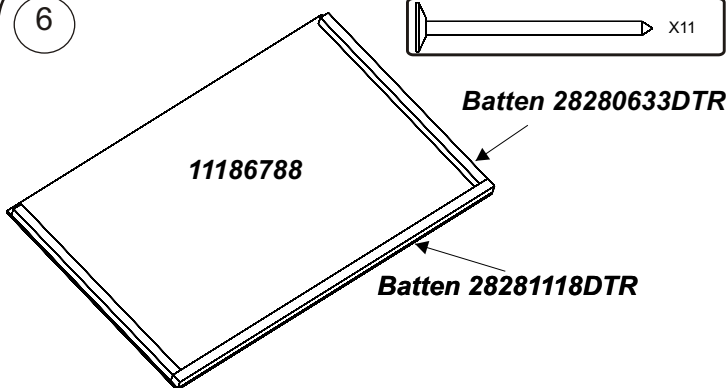
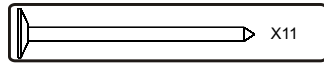

FIX THE ROOF SHEET ON TO THE 633mm BATTENS AND THE 1118mm BATTEN, POSITIONED AS SHOWN.

FIX EACH IN PLACE USING 30mm NAILS.

3x30mm NAILS FOR THE 28280633DTR
5x30mm NAILS FOR THE 28281118DTR

7

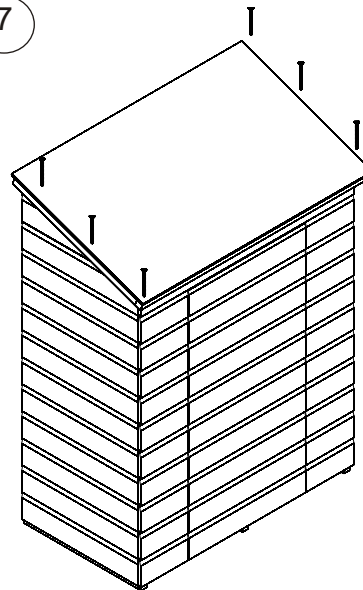
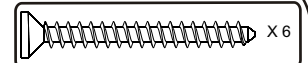

POSITION THE COMPLETED ROOF ON TO THE TOP OF THE STRUCTURE SO THAT THE BATTEN ON THE LONG SIDE IS OVERHANGING THE FRONT.

SECURE IN PLACE USING 6x30mm SCREWS AS SHOWN, TAKING CARE TO SCREW INTO THE BATTENS UNDERNEATH.

8

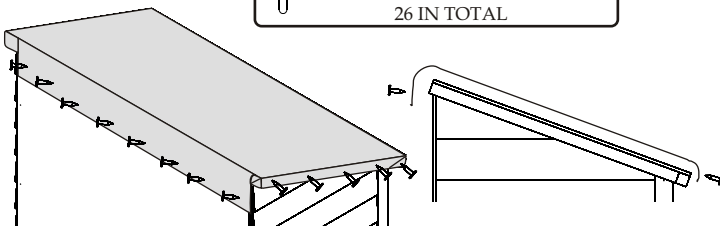

OPEN THE ROOFING FELT AND ROLL OUT FLAT ON THE GROUND.

WHEN THE FELT HAS FLATTENED, PLACE IT ON THE ROOF SO THAT IT OVERLAPS EQUAL AMOUNTS AT THE LEFT AND RIGHTHAND SIDE OF THE SHED, AND BY APPROXIMATELY 40mm AT THE FRONT OF THE ROOF. SECURE THE FELT WITH FELT NAILS PLACED AT 150mm INTERVALS ALONG THE OUTER EDGES OF THE ROOF.

CUT AND FOLD FELT AT THE CORNERS AND SECURE FOLD WITH A FELT NAIL. FOLD FELT OVER THE BACK OF THE UNIT AS SHOWN ABOVE AND SECURE TO OSB BACK WITH FELT NAILS PLACED AT 150mm INTERVALS.

9

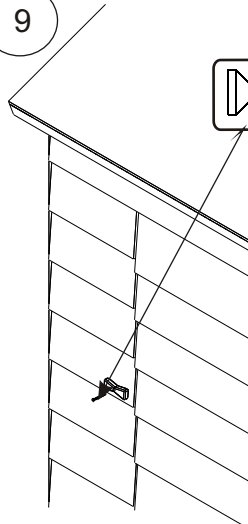
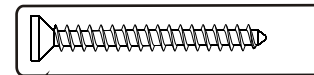

ATTACH THE TURN BUTTON TO THE UNIT WITH ONE 30mm SCREW. THE SCREW MUST LOCATE ON TO THE FRAMEWORK OF THE FRONT AND POSITIONED SO THAT IT WILL HOLD THE DOOR CLOSED.